

WELCOME OF ISCAR'S WORLD

February - 2020

Not a Small Challenge Cutting Tools for Miniature Dental and Medical Parts

Innovative and dynamic parts
in today's miniature dental and
medical components [pg. 4]

From CAD/CAM to Tool Assembly

The ISO 13399 standard
specifies data representation
for cutting tools and tool
holders [pg. 30]

High IQ Tools Optimize Metalworking in a Digital World

The digitization of manufacturing
– a key element of Industry 4.0
[pg. 34]

The Temperature Effect in Turning

Supplying coolant directly to the
cutting edge [pg. 38]

3X MORE DRILLING PERFORMANCE

LOGIQ 3 CHAM
THREE FLUTE CHAMDRILL

Member IMC Group
iscar
www.iscar.com

Increase Your Productivity Through Knowledge. Download The **ISCAR WORLD App** Now!

LOGIQ
ISCAR CHESS LINES



Robots



Internet of Things



Big Data



Cloud



3D



Simulation



System Integration

Member IMC Group
iscar
www.iscar.com



App Store



Play Store

All ISCAR's online apps, interfaces, and product catalogs in a single space.

Table of Contents

Not a Small Challenge	4
Tool Holding	12
Forming a Chipformer	16
Tools for Large Part Manufacturing	22
From CAD/CAM to Tool Assembly	30
High IQ Tools Optimize Metalworking in a Digital World	34
The Temperature Effect in Turning	38
Industrializing 4 Die and Mold Making	42

Not a Small Challenge

Cutting Tools for Miniature Dental and Medical Parts

Successful development of innovative and dynamic parts in today's miniature dental and medical components industry presents a formidable and equally dynamic challenge to cutting tool manufacturers.

The fast-growing field is driven by enterprising orthopedic surgeons and dental professionals together with medical device manufacturers, who work in cooperation with machine and tool manufacturers to transform their inventions into parts that are revolutionizing medical and dental procedures.

The materials for producing medical screws and implants are titanium superalloys, although stainless steel hard materials are utilized when a special ratio of depth of cut to chip thickness is required. These materials are gummy and cause built - up edge (BUE), which tends to wear down edge sharpness, while the high temperatures generated during chip breaking shorten tool life and damage surface quality. ISCAR applies unique geometries, tools, and grades to resolve these issues and create custom tool assemblies for the complex series of operations involved in machining miniature medical parts, such as dental screws and hip joint replacement implant components.

ISCAR applies unique geometries, tools, and grades to create custom tool assemblies for the complex series of operations



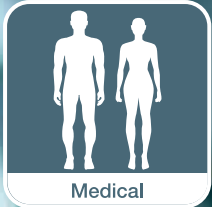



Dental Screws

For rough OD (outer dimension) turning, ISCAR developed a **SWISSCUT** compact tool designed for Swiss-type automatics and CNC lathes, which enables reduced setup time and easy indexing without having to remove the toolholder from the machine.

Another option features **SWISSTURN** toolholders, with a clamping mechanism to optimize insert clamping and replacement on Swiss-type machines, and **JETCUT** high pressure coolant tools. **SWISSCUT** tools perform the turn threading.

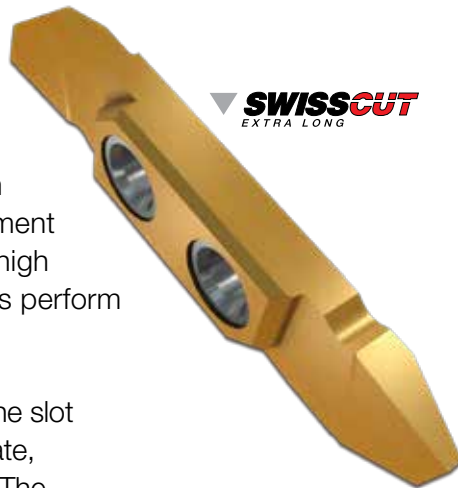

CHATTERFREE endmills are utilized for the slot milling stage to maximize stock removal rate, eliminate vibration and reduce cycle time. The ground geometry provides excellent surface and tool life, while machining at high material removal rates.

PENTACUT parting and grooving inserts perform the cut-off operations. With 5 cutting edges and very rigid insert clamping, **PENTACUT** is a stronger insert for higher machining parameters particularly on soft materials, parting of tubes, small and thin-walled parts.



SWISSCUT tools are used for face and OD turning (screw head turning), and **SOLIDDRILL** solid carbide drills, with 3xD and 5xD drilling depths and right-hand cut, for the drilling. The drills feature coolant holes.



The thread milling stage uses **SOLIDTHREAD** thread mills, whose short 3-tooth cutting zone with 3 flutes and released neck between the cutting zone and the shank enable precise profiles and high performance. The extremely short profile exerts a low force which minimizes tool bending, facilitating parallel and high thread precision for the entire length.



Solid carbide **SOLIDMILL** endmills with 2 flute, 30° helix medium length, perform the key head milling operation.

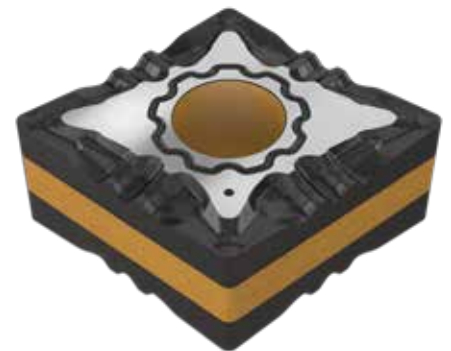

Hip Joint Implant Parts

Femoral Head

The machining required for a femoral head involves rough turning or rough grooving, semi-finish profile turning, rough drilling, semi-finish milling, semi-finish internal turning, internal grooving (undercut), cut-off, rough turning, and semi-finish turning.

ISOTURN offered in all standard geometries, the trigon (semi-triangular) turning inserts for axial and face turning features six 80° corner cutting edges. For profile machining, ISCAR provides intricate and precise **V-LOCK** V-shaped special profile grooving inserts for the range of 10-36 mm (.375-1.415 in). Precision ground and utility **CUT-GRIP** full-radius inserts are employed for the semi-finish turning stage.

SUMOCHAM integrates a clamping system that enables improved productivity output rates, a shank designed with twisted nozzles, and a durable and stable body.

CHATTERFREE 4-flute endmills are utilized for semi-finish milling; the endmills feature 38° helix and variable pitch for chatter dampening with 3xD neck relief. **CHAMGROOVE** internal grooving inserts are applied for semi-finish grooving. The inserts possess extremely small bore diameters starting at just 8 mm (.315 in) (the other diameters are 11 mm (.433 in) and 15 mm (.591 in)) and incorporate internal coolant.

Semi-finish internal turning is done by **ISOTURN** inserts with **SWISSTURN** toolholders and the cut-off operation uses **DO-GRIP** twisted double-sided parting inserts, which feature double-ended twisted geometry for no depth of cut limitation. For rough turning, the **SWISSTURN** ISO standard insert range with small shank sizes is used. Semi-finish turning is performed by **CUT-GRIP** inserts. In addition to the large variety of general-use precision ground and utility inserts in the **CUT-GRIP** family, there is a vast range of inserts for specific applications and materials.



Acetabular Shell

Machining of the acetabular shell component consists of rough internal turning, finish profile milling, shouldering, upper and bottom chamfering, drilling, thread milling, external rough turning, and external grooving.

HELI-GRIP double-ended inserts are used for rough internal turning, as the twisted design allows them to groove deeper than the insert length. Internal finish milling is performed by **SOLIDMILL** 3-flute, 30° helix short solid carbide ball nose endmills. **SOLIDMILL** endmills with 4 flutes, 38° helix, and variable pitch for chatter dampening, perform the finish shouldering operations, and a special-shaped endmill is utilized for the upper and bottom chamfering that follows the drilling stage.

SOLIDDRILL solid carbide drills with 3-20 mm (.185-.765 in) range and 3xD and 5xD drilling depths are used for the drilling process. **SOLIDDRILL** tools feature a right-hand cut with and without internal coolant nozzles and advanced TiAlN coating for optimum hole quality, high performance reliability and economical output.

Thread milling is done by **SOLIDMILL** solid carbide internal threading endmills, which integrate coolant holes for ISO thread profiles. ISO standard inserts with **SWISSTURN** toolholders with **JETCUT** high pressure coolant are used for rough turning, and external grooving is performed with **CUT-GRIP** precision inserts.

SOLIDMILL endmills with 4 flutes, 38° helix and variable pitch for chatter dampening with 3xD relieved necks, and **SOLIDMILL** 3 flute, 30° helix short solid carbide ball nose endmills perform the final milling operations.

The machining required for a femoral head involves different operations, including rough turning and drilling, internal grooving and milling



▲ **CUTGRIP**



▲ **ISOTURN**

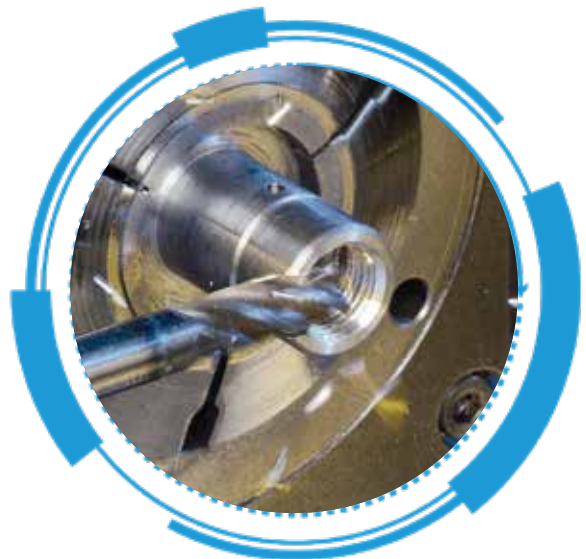

▲ **SOLIDMILL**
SOLID CARBIDE LINE

Femoral Stem

Machining the femoral stem involves slotting, spot milling, drilling, chamfer milling, turning, face and profile milling.

MULTI-MASTER endmills with indexable solid carbide heads in the diameter range of 12.7-25 mm (.500-1.000 in) are used for slotting. Spot milling is performed by means of **SOLIDMILL** endmills with 4 flutes, 38° helix and variable pitch for chatter dampening with 3xD relieved necks. The drilling operation uses **SOLIDDRILL** solid carbide drills with a range of 3-20 mm (.185-.765 in) and 3xD / 5xD drilling depths.

Chamfer milling uses **MULTI-MASTER** endmills with indexable solid carbide heads in the diameter range of 9.1-20 mm (.360-.750 in). ISO standard geometry inserts with precision ground cutting edges are used with **SWISSTURN** toolholders featuring **JETCUT** high pressure coolant for the turning stage.

SOLIDMILL 3 flute, 30° helix short solid carbide ball nose endmills with a 3-25 mm (.125-.625 in) diameter range are employed for profile milling, and **SOLIDMILL** endmills with 4 flutes, 38° helix and variable pitch for chatter dampening with 3xD relieved necks with a 1-8 mm (.125-.312 in) diameter range are utilized for face milling.



MULTI-MASTER
INDEXABLE SOLID CARBIDE LINE

SOLIDMILL
TEC LINE



Bone Plate

For rough milling, the **FINISHRED** endmill geometries allow the tool to perform roughing and finishing at the same time. **MULTI-MASTER** interchangeable solid carbide tapered heads are applied to the finish milling operation, whereby the curved surfaces can be machined by tilting the tool and applying a large corner radius at small cutting depths. Shouldering is done with **CHATTERFREE** endmills, which enable high material removal rates, eliminate vibration, and reduce cycle time.

The final milling stage engages **MULTI-MASTER** 4 flute, 30° helix short solid carbide ball nose endmills in the 5-25 mm (.190-1.000 in) range. **SOLIDDRILL** solid carbide drills, with no coolant holes and 4xD drilling depth, ensure stable and accurate drilling. Mill threading is achieved with **SOLIDTHREAD** 55° or 60° profile solid carbide taper thread mills.

Carbide Grades

Carbide grades specifically designed for machining applications on stainless steel and super alloys such as **IC900, IC907, IC806, IC908, IC328, and IC928** are ideal for milling and turning titanium and nickel based alloys, such as Nitinol, commonly found in medical components.

It is no small challenge to manufacture miniature parts for dental and medical devices but ISCAR has succeeded in developing highly effective cutting tools for this field that adhere to the stringent standards of quality and precision essential for medical industry applications.

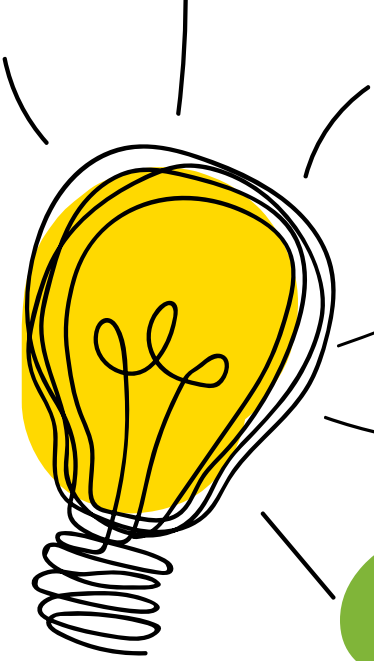

Tool Holding

New Demands

New Solutions

Toolholders act as an interface between cutting tool and machine, and they should ensure proper clamping of the cutting tool and also be suitable for mounting in the fitted spindle or tool changer magazine of a machine tool. The metalworking industry has compulsory standards to strictly specify the matching surfaces for both these purposes. These standards define a wide range of existing tooling systems to meet different manufacturer requirements: simple holders for manual tool changing for conventional machines with hand control, precise high - grade - balanced adaptors for high-speed machining centers, etc.

Tooling today is evolving along with metalworking industry developments in the world of Industry 4.0 and its impact on state-of-the-art manufacturing and new technological horizons.

Implementation of new technologies in high speed machining has necessitated a new level of tool balancing to ensure performance and reliability in a significantly expanded range of rotational speeds, with the objective of improving strength, rigidity, accuracy and other technical parameters of the traditionally designed toolholders. High - efficiency milling of difficult - to - cut aerospace materials, like titanium alloys, has increased the need for durable toolholders working in hard conditions.

High-efficiency milling of difficult-to-cut aerospace materials, like titanium alloys, has increased the need for durable toolholders working in hard conditions



Clamping and Cooling

ISCAR's range of arbors, holders, adaptors, blocks, thermal and power chucks are designed for effective tool clamping. For example, **SHRINKIN** thermal shrink chucks with HSK 100 shanks features G2.5 balance quality and a residual unbalance of less than 1.0 g·mm (.00139 oz·in) at 20000 rpm, MAXIN 32 power chucks ensure clamping torque up to 1760 N·m (1300 lbf·ft), and **FINEFIT** radial and angular alignment tool holders for high speed reamers maintain radial and axial runout adjustment to 0.001 mm (.00004 in).

Cooling is critical in operations such as machining titanium or exotic high temperature superalloys (HTSA), which are common for the aerospace industry.



A series of new tooling families ensures an effective pinpointed coolant supply, including **X-STREAM SHRINKIN**, a family of thermal shrink chucks with coolant jet channels along the shank bore. The patented design combines the advantages of high-precision heat shrink clamping with coolant flow directed to the cutting edges.

X-STREAM SHRINKIN has already shown excellent performance in milling aerospace parts such as titanium blades and blisks (bladed discs), particularly in high speed milling. In machining deep cavities, the efficient cooling provided by the new chucks substantially improves chip evacuation and diminishes chip recutting.

Turning

ISCAR has developed a new concept for high pressure coolant supply for VDI DIN 69880 quick-change adaptation systems, intended for turning machine tools. The **JETCUT** concept is based on bottom-fed high pressure coolant channels and provides coolant supply internally through the tool and externally through the flange.

A wet coolant can act as an excellent tool in a radically different field: increasing the rotational speed of a tool. ISCAR's **SPINJET** family of coolant-driven high speed compact spindles for small diameter tools helps upgrade existing machines to high speed performers. The **SPINJET** spindles are recommended for tools up to 7 mm (.275 in) in diameter; however the optimal diameter range is 0.5-4 mm (.020-.157 in). Depending on pressure and coolant flow rate, the spindles maintain a rotational speed of up to 55000 rpm.



▲ **SPINJET**
HIGH PRESSURE COOLANT



▲ **JETCUT**

▼ **ERCOLLET**



Reaming

In reaming, floating chucks are used in high-precision hole making to correct any misalignment between the central axes of a reamer and a hole. Precise alignment is essential for optimal performance and hole accuracy. To this end, ISCAR added a new design of GFIS floating chucks for high speed reamers to the **ER COLLET** chuck family.

Forming a

CHIPFORMER

The rake face determines the cutting geometry of a tool and its formation represents a key element of insert design.

Over the years, technological constraints have largely dictated the shape of the rake face. Breaking a long chip when turning by tools carrying these inserts often required using additional cover parts mounted in the tools above the inserts. Another common solution for flat-face turning inserts was to produce a chip breaking dimple by grinding. The dimple facilitated curling the chip in a spiral and then its breaking into smaller segments.

The chip breaking cover part obstructed chip flow, while the chips caused intensive abrasion of the part and significantly reduced its tool life.

The technology of sintered carbide products facilitated the shaping of insert rake faces in various forms and broke the dependence of a chip breaking surface on the dimple or the cover part. The rake face took on an appearance that combined concave and convex portions, local protrusions, etc. This complex geometry was designed to provide the necessary chip formation and effective chip control.



CAD Impact

CAD provides tool designers with a powerful tool for complicated 3-D modelling, engineering calculations and analyzing possible limitations of a designed insert and, of course, its rake face.

The combination of state-of-the-art sintered product technology, CAD systems and CNC machines marked a quantum leap in the cutting tool industry, enabling production of a wide variety of inserts with geometrically complex faces as well as a shorter design process.





Design for Milling

In the case of milling inserts, the rake face shape is considered mainly from the point of view of chip forming only - milling is a process of interrupted cutting and therefore chip breaking creates no difficulties. The rake face of the turning insert is also intended mainly for chip formation, though it should enable chip breaking. In the context of geometry, the rake face of every indexable insert is a combination of concave and convex areas.

Effect of 3D Modelling

Three-dimensional chip formation modelling represents a new powerful design tool for the cutting tool industry. Further development, based on the finite element method (FEM), raised cutting action modelling systems to a whole new level.

Today, cutting tool designers utilize advanced software to simulate chip formation processes with a sufficient approximation to reality.

Even though the software still cannot replace machining tests, it can contribute greatly to the effective design of the indexable inserts and, most of all, their rake faces

Matching Geometry to Operation

ISCAR has implemented modelling practices that allow R&D engineers to determine which insert geometry is appropriate for which operation, even at the design stage. When designing the **CNMG** 120404-F3P turning insert, for example, it was found that simulating cutting action was useful for shaping the insert's top surface.



▼ **SUMOCHAM**
CHAMDRILL LINE

▲ **ISOTURN**

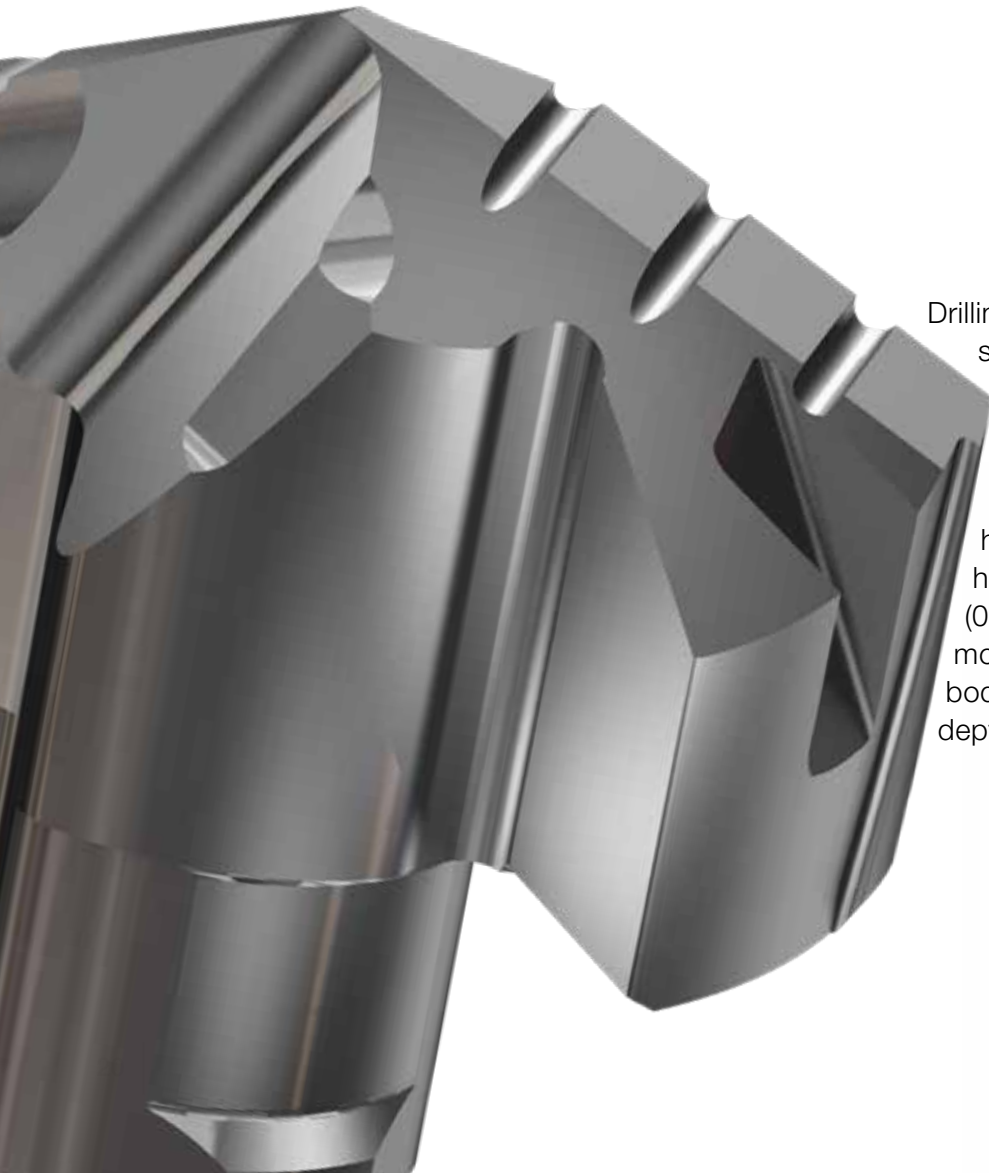

Drilling hard-to-cut austenitic and duplex stainless steel presents difficulties, especially if the depth of a hole is substantial. To improve performance in these types of drilling operations, ISCAR developed **ICG** exchangeable carbide heads with chip splitting geometry. The head diameter range is 14-25.9 mm (0.551-1.02 in) and the heads are mounted in standard **SUMOCHAM** drill bodies to provide high-quality holes with depth up to 12×D.



NANMILL Milling Cutters

ISCAR recently introduced a series of indexable mills in the small-diameter range (up to 20 mm or 0.75 in). Although this range is traditionally considered as more suitable for solid carbide tools, the new indexable mills represent an attractive and cost-beneficial alternative. The **NANMILL** family of indexable milling cutters within the diameter range of 8-16 mm (0.315-0.625 in) integrates a new design concept, with a clamping screw located above the insert and a screw head that functions as a wedge.



NANMILL
NANO ENDMILL

Further progress in modelling cutting action should bring tool designers closer to achieving optimal chip forming geometries and improve the quality of the designed tool.



Tools For Large Part Manufacturing

In principle, machining large parts involves the same cutting action and chip formation process as for small or mid-size parts. However, large dimensions demand a specific approach to machining, and manufacturers need to plan technological processes and choose more effective cutting tools in order to produce heavy parts that take up a great deal of space.

Machining large parts involves removing a lot of material that may cause significant deformations due to unrelieved stresses. Another factor, which leads to dimensional problems, is thermal expansion caused by heat generation during cutting.

Single setup machining represents an absolute ideal for machining a large part, and producers from fields such as power generation, aerospace, railway, die and mold making, and heavy industry make every effort to approach this ideal.

Large part manufacturers expect the same from cutting tools as any other producer using metal cutting technologies: excellent performance, good tool life, and high reliability. The latter two are especially essential because the large sizes lead to increased machining time, but replacing a worn tool in the middle of a pass and unpredictable breakage of the tool during cutting are totally unacceptable.

The key for overcoming the difficulties lies in technology, based on effective process planning and utilizing the most suitable machine tools



Heavy-Duty Facing

It is hard to machine a large part without face milling operations. Rough and fine machining of free and bounded planes and preparing datum surfaces require various indexable face mills. ISCAR's standard face mills possess nominal diameters up to 315 mm (12 in), while special tailor-made tools might feature higher values. Significant removal of machining stock by milling is primarily an issue for the production of large parts from steel and cast iron and, slightly less, from titanium and aluminum.



ISCAR's line of standard face mills includes many tool families for large part manufacturing. **HELITANG** T465 features cutters with a 65° cutting edge angle and carrying tangentially clamped inserts. The robust design enables productive machining with a depth of cut up to 19 mm (.750 in). The **HELIDO 890** family features 89° face mills with lay-down square double-sided inserts which provide 8 indexable cutting edges for depth of cut up to 9 mm (.354 in), offering an important economic advantage.

HELIDO ▼
865 LINE

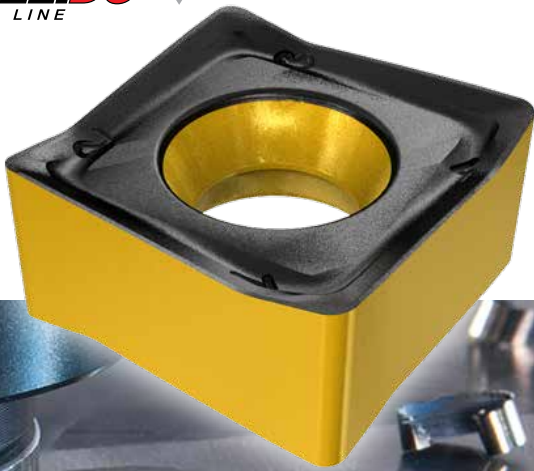

HELITANG ▼



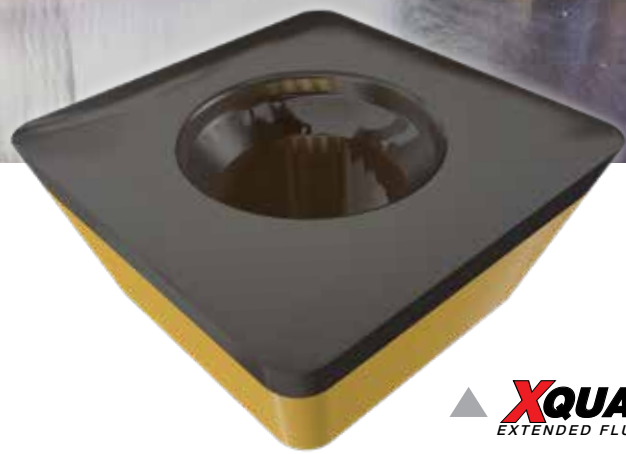
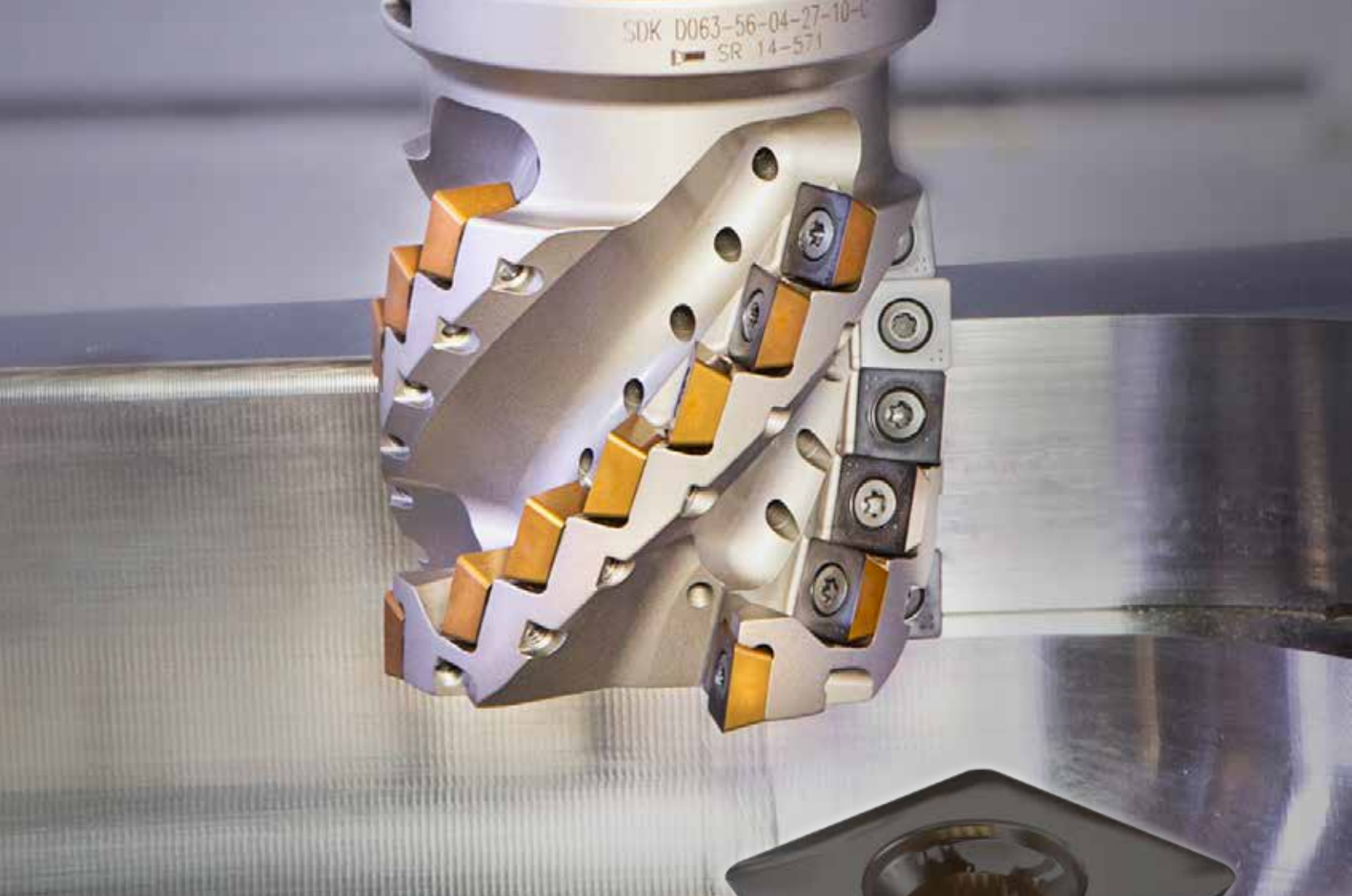

Extended Flutes

ISCAR's line of indexable extended flute cutters varies in design configuration, integrating a shank- and arbor-type mounting method and a radial or tangential insert clamping principle. Intensive material removal requires the appropriate volume of a tool chip gullet to ensure effective chip evacuation. The situation can be dramatically improved by applying ISCAR's extended flute cutters carrying inserts with chip splitting geometry to divide a wide chip into small segments. As a result, cutting forces are reduced, vibrations are stabilized, and thermal problems are eased.

Although 90° tools are the most commonly used cutters, machining large parts also requires rough milling of inclined and 3D surfaces, for which ISCAR provides a family of tapered extended flute cutters with 22.5°-75° cutting edge angles. The **DROPMILL** 3 extended flute ball nose mills were designed specifically for such applications.



Producing large-size aerospace components from hard-to-machine titanium alloys is an extremely metal-intensive process with a significant buy-to-fly ratio. The eventual weight of a part may be only 10%, or even less, of the original weight of a workpiece. The **XQUAD** extended flute cutter family, one of ISCAR's newest products, is intended for high-efficiency milling of deep cavities and wide edges in titanium parts. The tools have already proved themselves: for example, component producers have achieved a 700-1000 cm³/min (43-61 in³/min) metal removal rate (MRR) by using an 80 mm (3 in) diameter **XQUAD** cutter.

Productive Milling

High feed mills machine at shallow depths of cut but with a feed per tooth that is far higher than the usual rates - millimeters as opposed to tenths of millimeters. Fast feed mills are applied mainly to rough machining of plane faces, cavities and 3D surfaces.

ISCAR has a wide choice of fast feed mill families, intended for cutting various materials in different applications. The “world” of ISCAR’s high feed milling cutters encompasses tool families in diameter ranges of up to 160 mm (6.3 in) that can meet the requirements of the most demanding customer.

Large part manufacturers often have heavy, powerful but slow machines that are not suitable for high feed face milling. For these customers, ISCAR developed moderate feed cutters. Compared with fast feed mills, moderate feed cutters feature a higher cutting edge angle; they move slower but machine at higher depths and need more power to make them suitable for applying to heavy machines.

The welded part structure and the process of repairing worn parts by spraying fillers or soldering, add materials that are not easy-to-machine either. Originally applied in die and mold making, high speed milling was developed as a productive method of milling hard steel that led to decreasing a part relocation, lessening setup, minimizing manual finish and polish, and, as a result, reducing cycle time.

The most suitable high speed milling tool is a solid carbide endmill and ISCAR’s **MULTI-MASTER** family of assembled endmills, which carry cemented carbide exchangeable heads, also represents a viable option. ISCAR’s line of solid carbide endmills offers multi-flute tools in diameters of up to 20 mm (.750 in) for high speed milling materials with hardness up to HRC 70.



▲ **DROP MILL**
3 FLUTE BALL NOSE



▲ **MULTI-MASTER**
INDEXABLE HEADS



SUMOCHAM
CHAMDRILL LINE



MILL4FEED
HIGH FEED



ISOTURN



Exchangeable Heads

ISCAR's families of rotating assembled tools with exchangeable heads - **MULTI-MASTER** mills and **SUMOCHAM** drills - enable substantial decreases in downtime, a critical parameter particularly for small volume and individual manufacturing.

Face contact between a head and a tool body ensures that the head overhang is within strict tolerance limits, resulting in high dimensional repeatability of the assembly.

Turn Milling

Turn milling is a good option for machining heavy rotary parts. In turning, the cutting speed is a function of rotating velocity. If the main drive of a machine tool does not allow rotation of large masses with the required velocity, due to limitations of its working characteristics, then the cutting speed is far from the optimal range and turning performance will be low. When turning large eccentric parts like crankshafts, off-center masses of the parts cause unbalanced forces that adversely affect performance. Turn milling features low rotary velocity of a part, which prevents this negative effect.

The majority of ISCAR's indexable face milling cutters are suitable for turn milling. The success of their application depends on cutter positioning with respect to the machined part, choosing optimal geometry of inserts, and cutting data calculation.

Most of ISCAR's indexable face milling cutters can be used for turn milling, depending on the cutter position in relation to the machined part, optimal insert geometry, and cutting data calculations

From CAD/CAM to Tool Assembly

Digitizing of manufacturing industries is one of the distinct technological breakthroughs stimulated by the “fourth industrial revolution” - the implementation of INDUSTRY 4.0 standards.

The **ISO13399** standard specifies data representation for cutting tools and tool holders, in a manner that will ensure platform independence universally. The main target is to create a computer representation of the tools and the holders that is unified and understandable for various elements of metalworking technology, whether they are real or virtual, including computer aided design and manufacturing (CAD/CAM) systems.

Immediate and simple access to digitized tool data has become of strategic importance in the service

provided by a tool producer. From process planning technologists, tool design engineers and CNC programmers to application specialists and sales managers - all might spend hours adopting tool manufacturers tool data to the customer's software. Data transfer is conducted via a STEP file with .p21 extension, which stores text code related to the parametric values of the product. In addition, the .p21 file provides the name of the 3D file of a specific product. **ISO13399** stipulates the .p21 file which can be transferred between computer platforms for CAD and CAM users.





The assembly ensures fast and reliable simulation of the operation as well as collision (interference) checking, tool path optimization, and the design of workholding fixtures. As the selected machining method results in the value of forces acting on workpieces and a tool configuration influences the shape of workholding elements, simulating the operation with the use of the tool assembly model represents an effective instrument for workholder design.

The analysis is performed in a virtual manufacturing environment and not on the shop floor, which minimizes and even prevents possible errors during real cutting. The assemblies created are accessible for downloading in both 3D and 2D formats to facilitate the preparation of drawings, drafts and other engineering documents.

The tool assembly model is platform-independent and is intended to be integrated into the user's own CAM software, to prevent errors on the shop floor during machining.

The ability to plan and examine single- and multiple tool assemblies in the early stages of manufacturing is an extremely valuable source of time and cost saving. The tool assembly options offer an appropriate and effective answer to the needs of modern metalworking, and more E-CAT tool assembly applications are near at hand to assist metalworking manufacturers in the evolving world of INDUSTRY 4.0.

E-CAT integrates an advanced filtering system to enable the selection of the most suitable tools for the planned operation, based on machining parameters



High IQ Tools

Optimize Metalworking in a Digital World

INDUSTRY 4.0 is redefining production methods and the metalworking industry is taking note.

New demands have affected and influenced almost every related technology: from planning and communication networks to machinery and cutting tools - arguably the most conservative element in a manufacturing system.

Digitization in the cutting tool field has two emerging trends. The first trend is to enable the cutting tool to communicate with advanced machinery and cyber physical production systems in order to advise about tool wear, predictable tool life, total time of the tool involved in cutting etc.

The second trend relates to information about the tool that should be provided by a cutting tool manufacturer.

A good illustration is the **ISO13399** standard, which specifies computer representation and data exchange for information about the cutting tools and their holders - a first step for making the tool digital data platform-independent. Only tools digitally specified in accordance to this standard will be utilized by smart factories, making comprehensive digitized data sources an important direction for cutting tool manufacturers; this integration of data will form an inseparable part of a cutting tool.

ISCAR recognizes the central importance of developing and adopting digitized solutions for metalworking operations.





MATRIX, an automated tool dispenser that is an integral shop-floor-level element of a smart factory, tool assembly options in 3D and 2D formats in E-CAT, ISCAR's electronic catalog – these are a few examples of products intended to unify the material and virtual worlds of smart manufacturing.



Virtual Assembly

In addition to the existing milling tool assembly option, E-CAT has enriched its instruments for virtual manufacturing by introducing a new assembly option that relates to drills and taps. This new function allows creating the twin representation of a drilling or tapping tool assembly based on the **ISO13399** standard. The assemblies are accessible in both 3D and 2D files, which can be downloaded from E-CAT on the ISCAR website and incorporated directly to a user's CAM system. As a result, various simulations of cutting operations, collision checking, finding an optimal tool configuration etc. can be performed.



Smart Scan

Data on ISCAR's tool dimensions, inserts, appropriate tool holders and recommended cutting data is accessible via the ISCAR 4.0 Pro mobile application, developed for maximizing tooling utilization. ISCAR 4.0 Pro is a smart 2D M barcode scanner that acts as a digital gateway to advanced tooling resources of the company, so that customers can make better decisions regarding tool selection and their realization on the shop floor. The information corresponds to the **ISO13399** standard and to the tool assembly, cutting conditions, tool material grades, weight, user manuals, and other items. The data is accessible by scanning the 2D Data M barcode, which appears on ISCAR tools and product packages.



A World of Information

ISCAR recently launched ISCAR WORLD, an expanded application that embraces all ISCAR's online apps, interfaces, and product catalogs in a single space. The app gives instant access to E-CAT, ISCAR 4.0 Pro, E-Commerce (an online tool ordering system), a media channel, ISCAR Tool Advisor – an expert system for tool selecting, technical data, machining calculations, frequently asked questions and more, enabling users to review, compare, check, and select the tooling solutions that are right for their needs. The application constantly updates and expands its store of knowledge by collecting new data, opening a virtual doorway to a whole world of updated information.

Smart manufacturing in the INDUSTRY 4.0 era features a combination of real and virtual worlds, based on network technologies, for every link of the manufacturing chain including cutting tools. Advanced manufacturing systems require cutting tools to “possess” a rich world of relevant data – a high IQ - as a necessary condition for incorporating the tool into their intelligent machining processes.

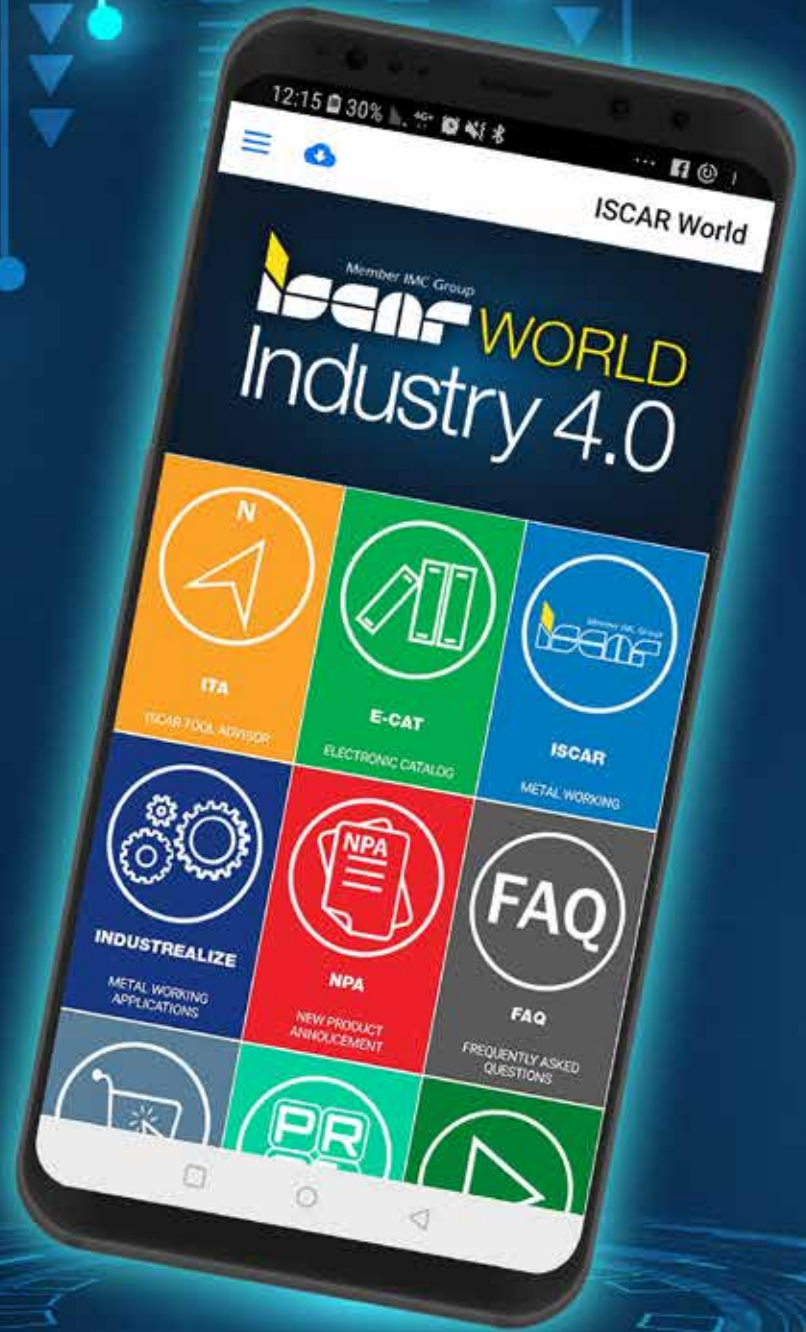

App Store



Play Store

The Temperature Effect in Turning

In the last few years, the concept and implementation of cooling solutions for cutting tools has enjoyed a surge of popularity and enthusiasm as if it had never existed before. CNC machine manufacturers throughout the world have invested time and resources to develop solutions that can supply coolant at high pressures and today all new machines are supplied with a high-pressure coolant option.

Manufacturers from industries such as aerospace, automotive, and large part production appreciate the immense advantage of supplying coolant directly to the cutting edge and are only ordering machines for milling centers or turning centers with high pressure coolant capabilities - minimum 70 bar and up to 300 bar. Mass production manufacturers are also benefiting from the integration of ISCAR's **JETCUT** tools into their processes. One of the most serious enemies of carbide inserts is the high temperature of the materials that results from the machining process. The average temperature during machining can range from 300°C to 900°C. As the temperature rises, the lifespan of the inserts is shortened. Increased wear can damage workpiece quality and negatively affect machining properties: the heat generated between the insert and the workpiece can cause a change in chip shape and plastic deformation of the insert. High pressure starting at 70 bar can be effective in breaking chips and, in cases when it is difficult to break chips and the chip formed is long and curled, coolant applied correctly and under high pressure can solve this problem.

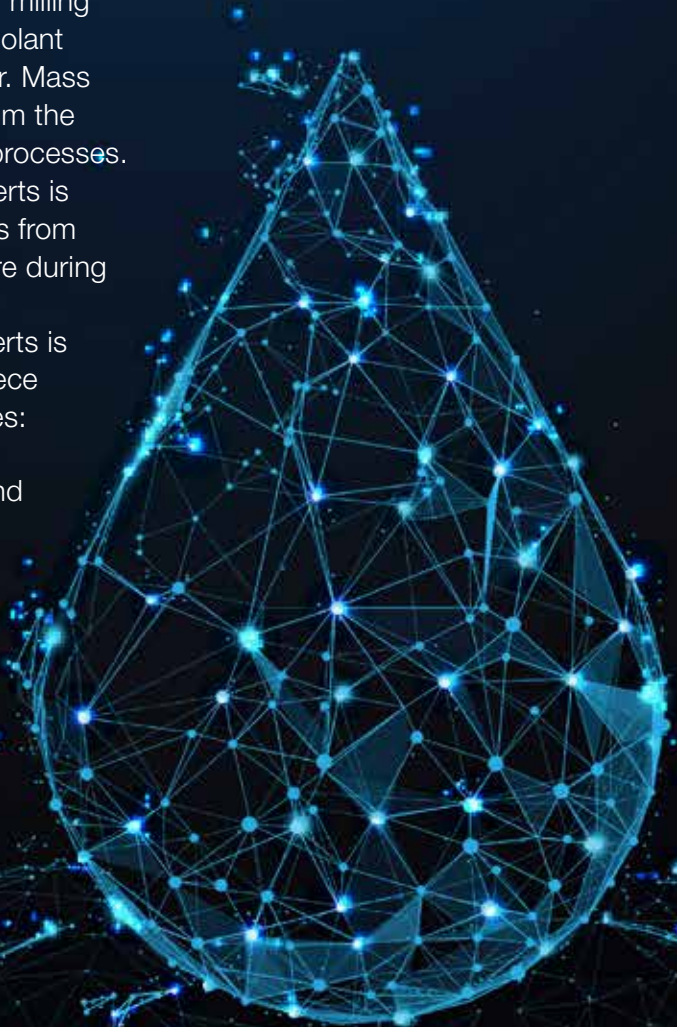



Cooling has a major influence on machining exotic materials such as Inconel, titanium, Hastelloy, Monel and other alloys, which are all used in the aerospace industry. These workpiece materials are difficult to machine as they have a very high nickel level and possess a tendency to stick to cutter edges due to their elastic, sticky and ductile properties - which is one of the reasons that parts for the aerospace industry are extremely expensive. Machining these types of materials without coolant is almost impossible, as the high temperatures and stickiness cause instantaneous wear and premature failure for carbide inserts.

Machining these types of materials without coolant is almost impossible, as the high temperatures and stickiness cause instantaneous wear and premature failure for carbide inserts

In addition to reducing temperatures for exotic metals, the use of coolant creates a shielded area between the insert and the workpiece material, so preventing material from sticking to the cutting edge – which is a major factor in premature failure for inserts.

In groove turn operations, it is particularly important to select the right grade for chip breaking. An incorrect choice of grade or chip breaker can spell disaster for the manufacturer.

ISCAR developed and integrated external and internal tools to deliver coolant directly to the cutting edge, including the **JETCUT** range. This has succeeded in increasing dramatically tool lifespan and productivity, even at low pressures such as 10 or 20 bar.

Manufacturers who work with problematic exotic materials such as Inconel, titanium and stainless steels have also managed to achieve higher productivity by incorporating **JETCUT** tools.

To answer to the growing demands of the many industry sectors, ISCAR expanded its jet high pressure line by adding turning tools fitted with the **JET-R-TURN** hollow rigid clamp, which also acts as a coolant nozzle. Until now, ISCAR's **ISOTURN** range of tools featuring a jet high pressure cooling option were designed with a lever clamping mechanism, as an upper clamp would obstruct the coolant jet from reaching the cutting edge. The new design enables jet high pressure coolant to reach the cutting edge without any obstacles. ISCAR offers tools with **JET-R-TURN** rigid clamp mechanism for the most popular standard CNMG, WNMG and DNMG insert geometries.



▲ **JETCUT**



▲ **ISOTURN**



▲ **LOGIQ FGRIP**
HIGH FEED GRIP HOLDER

Features

**Strong and reliable clamping mechanism
prolongs tool life**

- 💧 Coolant jet directed to the cutting edge
- 💧 Excellent corner location repeatability
- 💧 Excellent performance in heavy cut machining

**The new external tools feature three coolant
connection options**

- 💧 Rear threaded inlet
- 💧 Bottom threaded inlet
- 💧 Bottom inlet for adjustable shank overhang,
as in ISCAR's JHP-MC tools

What is a second in our life?

Every second can be multiplied and translated to millions of seconds when considering mass production of standard parts. Saving a single second multiplied by a million parts is equivalent to a whole working month, which represents a major saving and is the dream of every mass production manufacturer.

ISCAR today provides a wide range of **JETCUT** tools for a variety of applications, from turning and grooving to parting.

 **JET R TURN**
RIGID CLAMP



Industrializing 4 Die and Mold

Tool Material Grades, Methods,
and Digital Options for Production Effectiveness

The die and mold industrial branch not only consumes more and more tools but constantly puts forward new demands, which have a significant impact on advances in cutting tools. These demands are typical for every metalworking sector.

Specific features of die and mold manufacturing necessitate special design considerations beyond the general requirements.

Materials, machined shapes, and machining strategies are three distinctive hallmarks of die and mold making, and have a substantial influence on cutting tool demands. Only a holistic tool development concept based on these features, combined with integration of INDUSTRY 4.0 inspired developments, will lead to successful solutions for the die and mold sector.

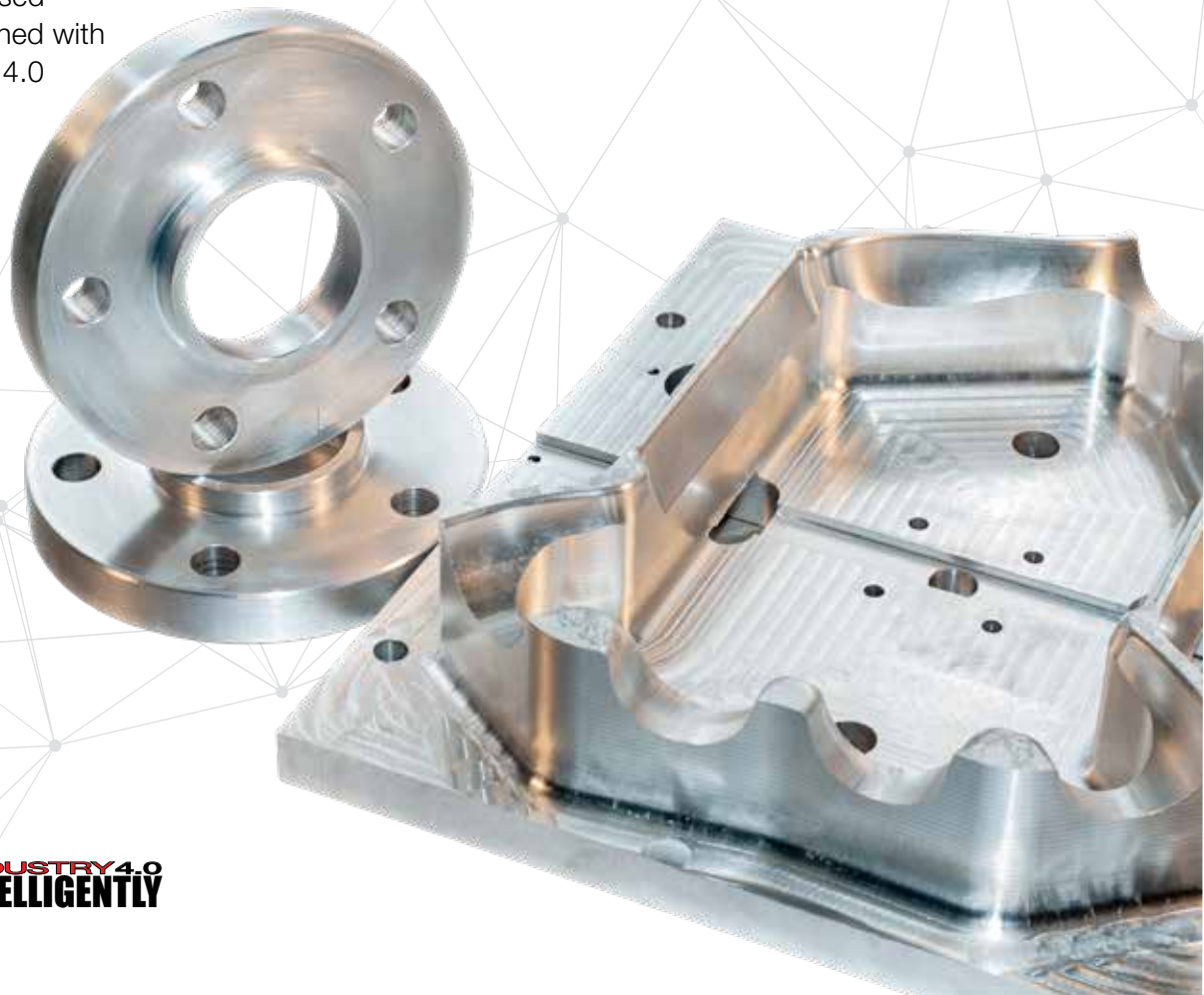

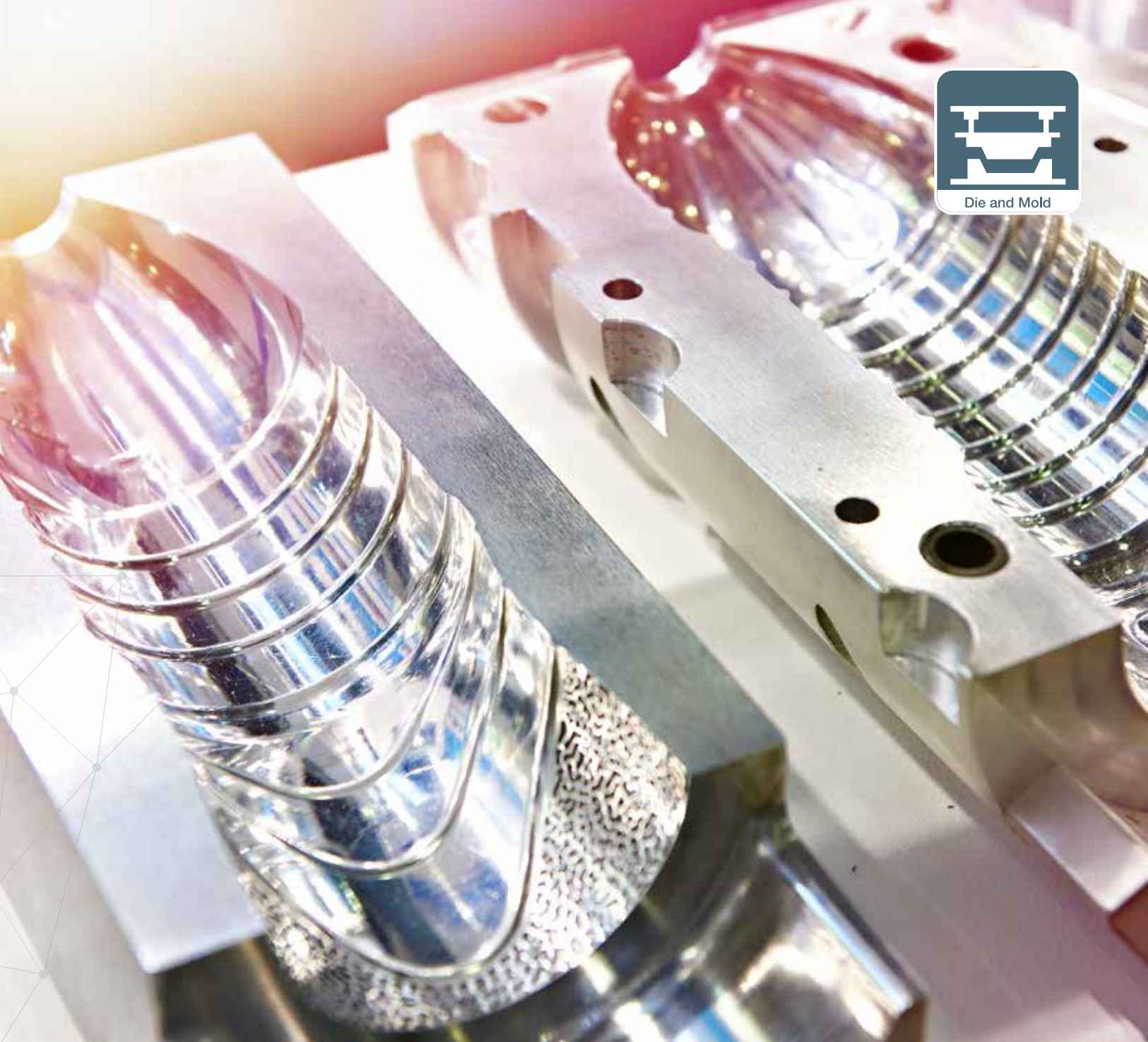

Challenging Materials

The main material for the die and mold industry is steel that is often hard to machine. Workpiece hardness is a principal factor in influencing tool material and cutting geometry. Further machining of these surfaces requires a cutting tool to remove a material stock combining very hard and relatively soft layers. This condition significantly reduces tool life and requires tool manufacturers to make extra efforts to compensate and ensure the necessary durability.

Intricate shapes

A three-dimensional (3D) profile is typical for the working surfaces of a mold (die) set, and the ability to machine 3D surfaces effectively is an important requirement for cutting tools. A tool is expected to provide the required parameters for shape accuracy and surface finish, and to ensure the appropriate level of tool life needed to complete machining the shape or its pattern in one operation.

Machining

Manufacturing molds and dies requires various machining processes: turning, milling, drilling, reaming and others, although cutting tools for die and mold making are associated primarily with mills. The specific character of the die and mold industry - predominance of non-rotating parts, the complex shape of machined surfaces, the necessity to produce a lot of cavities that require considerable material stock removal, etc. - positions milling cutters in the first place among tools utilized by this branch.

In their constant need to boost productivity in manufacturing molds and dies for new products, the die and mold industry was one of the first adopters of advanced machining methods such as high speed milling (HSM) and high feed milling (HFM), and to develop efficient machining strategies.



Tool Material Grades

In die and mold making, indexable extended flute (also referenced as long-edge) milling cutters are often applied to rough machining cavities and wide edges. The cutters work in high-load conditions, and the material of the indexable insert is a key factor for improving tool life. To achieve this objective, ISCAR recently introduced IC845, a cemented carbide grade, that features a new tough substrate and a new nanolayer PVD coating with applied **SUMO TEC** post-coating treatment technology.

The grade was designed especially for cutting at significant impact load. ISCAR's solid carbide endmill line has been enhanced by adding the IC702 carbide grade, which is intended for efficient machining of hard materials (up to HRC 65).

Advanced Profiling

In machining complex surfaces, the real workhorses are milling cutters of toroidal - (button) and ball - nose shapes. ISCAR offers die and mold makers an extensive line of these cutters in the following designs: tools with indexable inserts, endmills with exchangeable cutting heads, and solid carbide endmills. They differ in nominal sizes, accuracy, mounting method (shank - or arbor - type) and application range, according to whether the workpiece hardness is low, moderate or hard.

A **TOR6MILL** cutter can carry inserts in four different geometries. Mounting the appropriate insert in the cutter transforms it to a toroidal, 90°, 45° or high feed milling tool. The cutter can be applied to machining 3D surfaces, square shoulders, plane faces, chamfers, or use as a productive high feed rougher.

Innovative Technologies

High feed milling and high speed milling proved to be powerful methods for dramatically increasing machining productivity while reducing manual operations, consequently shortening production time significantly.



TR45



TR90

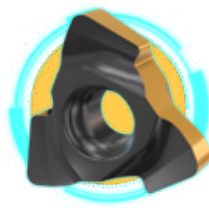

TRFF

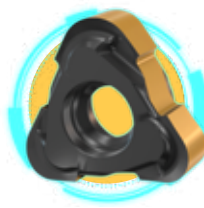

TR6

TOR6MILL
PROFILING

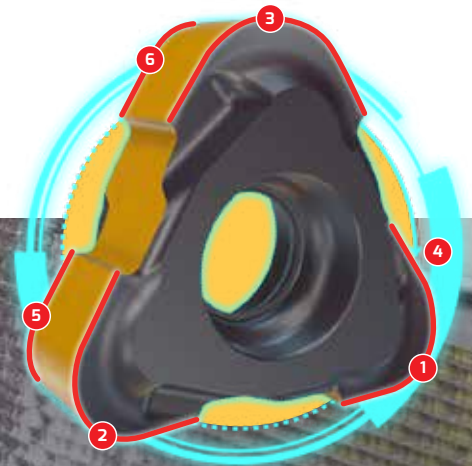



High Feed Milling

ISCAR's standard high feed milling line comprises more than 10 tool families that differ in their design principle (indexable, solid, with replaceable heads), nominal diameter, cutting geometry, mounting method and applicability (machining faces, pockets, deep cavities).

NAN3FEED and **MICRO3FEED**, two of the latest ISCAR families of indexable high feed milling tools, feature an 8-16 mm (.315-.625 in) diameter range.

Even though solid carbide endmills traditionally dominate this range, ISCAR's specialists believe that the advantages of the indexable-insert concept for rough machining will position the families as serious cost-effective alternatives to the solid carbide designs.



LOGIQ4FEED
HIGH FEED MILLING

The **LOGIQ4FEED** family of fast feed cutters features "bone-shape" double-sided inserts. This unusual insert profile provides four cutting edges, with an exceptional ramp-down capability that defines the main application of the family: high-efficiency rough milling of cavities, particularly deep cavities. The cutters are suitable for machining workpieces with hardness up to HRC 50.

FAST FEED MILLING

High Speed Milling

Expanding the range of products intended for high speed milling, ISCAR introduced multi-flute solid carbide endmills in 2-20 mm (.250-.750 in) diameters for high speed finish and semi-finish milling. The endmills are produced from the ultra-fine IC902 carbide grade, which was developed to machine hard materials, and have a cutting-length-to-diameter ratio of up to 6. They are operated at rotational speeds up to 20000 rpm.

MULTI-MASTER Options

ISCAR's **MULTI-MASTER** family of assembled tools with exchangeable cutting heads is a good choice for die and mold making. The **MULTI-MASTER** head is suitable for mounting on different tool bodies (shanks), and the shank can carry different heads. The heads are varied in shape, cutting geometry and sizes and are designed for machining 3D surfaces and shoulders, faces and slots, chamfers and holes. The cylindrical and taper-neck shanks feature different dimensions for a broad-ranging overhang; their design options ensure clamping in toolholders, collet chucks or in a machine tool spindle directly.

The **MULTI-MASTER**, with its rich variety of heads, shanks, reducers and extensions, enables thousands of possible tool configurations. The **MULTI-MASTER** tools wholly meet the requirements of the important "no setup time" principle, as replacing a worn head does not require additional setup operations. The head can be changed without removing a tool from a machine, which significantly decreases downtime.

Advances in industrial branches such as the automotive industry have had a major impact on die and mold needs, leading to new levels in cutting tool demands that should be heeded by tool manufacturers.

MULTI-MASTER
INDEXABLE SOLID CARBIDE LINE



ISCAR's Electronic Catalog Features **INDUSTRY 4.0** Milling Tool Assemblies Online

www.iscar.com

